

32X

ClampMeters

Calibration Information

Introduction

⚠ Warning

To avoid electric shock or injury, do not perform the performance tests or calibration procedures unless you are qualified to do so.

The information provided in this manual is for the use of qualified personnel only.

The *32X Calibration Information* provides the information necessary to verify the performance and adjust the calibration of the Fluke 321 and 322 ClampMeters, hereafter known as the Meter(s).

The following information is included in this document:

- Safety Information and International Electrical Symbols
- Specifications
- Replacing the Batteries
- Cleaning
- Performance Tests
- Calibration Adjustment
- User-Replaceable Parts and Accessories
- Warranty Statement

See the *321,322 Instruction Card* for complete operating instructions.

Contact Information

To contact Fluke, call:

1-888-99-FLUKE (1-888-993-5853) in USA
1-800-36-FLUKE (1-800-363-5853) in Canada
+31 402-675-200 in Europe
+81-3-3434-0181 Japan
+65-738-5655 Singapore
+1-425-446-5500 in other countries

For additional information about Fluke, its products, and services, visit Fluke's web site at:
www.fluke.com

To register this product, go to register.fluke.com

Safety Information













Warnings and Precautions

To avoid possible electric shock or personal injury, and to avoid possible damage to the Meter or the equipment under test, adhere to the following practices:

- Avoid working alone so assistance can be rendered.
- Never use the Meter on a circuit with voltages higher than 600 V or a frequency higher than 400 Hz fundamental. The meter may be damaged.
- Do not use the Meter or test leads if they look damaged.
- Use extreme caution when working around bare conductors or bus bars. Contact with the conductor could result in electric shock.
- Read the instruction card and safety sheet before use and follow all safety instructions.
- Use the Meter only as specified in the instruction card; otherwise, the Meter's safety features may be impaired.
- Use caution when working with voltages above 60 V dc or 30 V ac. Such voltages pose a shock hazard.
- Before using the Meter, inspect the case. Do not use the Meter if it is damaged. Look for cracks or missing plastic. Pay particular attention to the insulation around the connectors.
- Verify the Meter's operation by measuring a known voltage. Do not use the Meter if it operates abnormally. Protection may be impaired. When in doubt, have the Meter serviced.
- Do not apply more than the rated current or voltage, as marked on the Meter.
- Use the proper terminals, function, and range for your measurements.
- Do not operate the Meter with the case (or part of the case) removed.
- When servicing the Meter, use only specified replacement parts.

International Electrical Symbols

The following international symbols appear in this document and on the Meter.

	Risk of electric shock
	Risk of danger. Important Information. See manual.
	Equipment protected by double or reinforced Insulation
	Battery
	Conforms to CSA C22.2 No 1010. 2.032-96
	Conforms to EU directives
	Earth
	DC measurement
	AC measurement
	Conforms to relevant Australian standards
	Conforms to UL 3111-1 and UL 3111-2-032
	Inspected and licensed by TÜV Product Services

Specifications

*@ 23 °C ± 5 °C, 0 - 90% RH		321	322
\tilde{A} (50/60 Hz)	Range	0 - 400.0 A	0 - 40.0 A 40 .0 - 400.0 A
	Accuracy	50 Hz - 60 Hz 1.8 % ± 5 counts 60 Hz - 400 Hz 3.0 % ± 5 counts	
	AC Response	Avg	
\tilde{V}	Range	0 - 400.0 V, 400 - 600 V	
	Accuracy	50 Hz - 400 Hz 1.2 % ± 5 counts	
\bar{V}	Range	–	0 - 400.0 V, 400 - 600 V
	Accuracy		1 % ± 5 counts
Ω	Range	0 - 400.0 Ω	
	Accuracy	1.0 % ± 5 counts	
Continuity)))	$\leq 30 \Omega$	
Jaw Opening	1 inch (26 mm)		
IP Rating	40		
Storage Temperature	-40 °C to 60 °C		
Operating Temperature	-10 °C to 50 °C		
Altitude	2000 m		
EMC- EN61326			
CAT III 600 V, pollution degree II:			
CAT III equipment is designed to protect against transients in equipment in fixed-equipment installations, such as distribution panels, feeders and short branch circuits, and lighting systems in large buildings.			
* < 18 °C, > 28 °C add 0.1 x (specified accuracy)/ °C			

Replacing the Batteries

⚠ Warning

To avoid false readings, that could lead to possible electric shock or personal injury, replace the batteries as soon as the low battery indicator () appears.

Disconnect the test leads before replacing the batteries.

To replace the batteries (refer to Figure 1):

1. Turn the rotary switch to **OFF** and remove the test leads from the terminals.
2. Loosen the battery compartment door screw, and remove the door from the case bottom.
3. Remove the batteries.
4. Replace the batteries with 2 new AAA batteries.
5. Reattach the battery compartment door to the case bottom and tighten the screw.

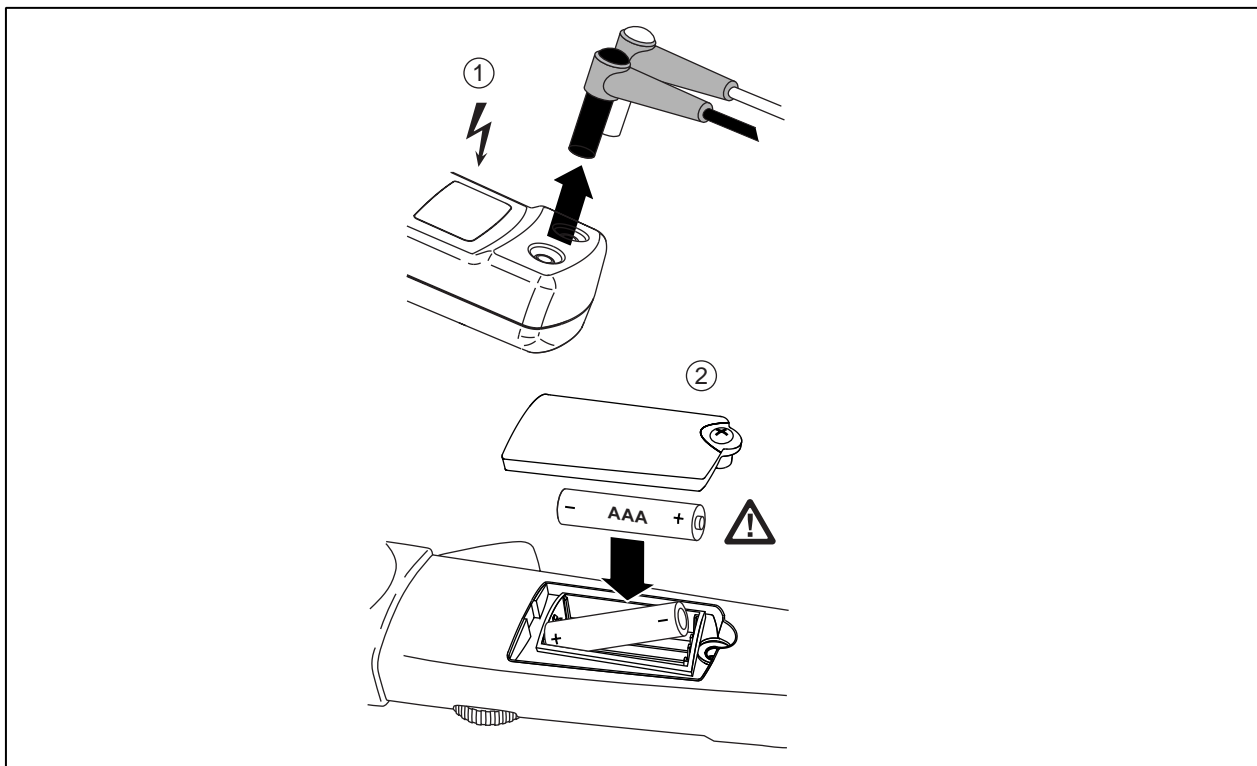

ade02.eps

Figure 1. Replacing the Batteries

Cleaning

⚠ Warning

To avoid electrical shock, remove any input signals before cleaning.

Caution

To avoid damaging the Meter, do not use aromatic hydrocarbons or chlorinated solvents for cleaning. These solutions will react with the plastics used in the instruments.

Clean the instrument case with a damp cloth and mild detergent.

Performance Tests

⚠ Warning

To avoid electric shock, do not perform the performance test procedures unless the Meter is fully assembled.

The following performance tests verify the complete operation of the Meter and check the accuracy of each meter function against the Meter's specifications. If the Meter fails any part of the test, calibration adjustment and/or repair is indicated.

In the performance tests, the Meter is referred to as the unit under test (UUT).

Table 1. Required Equipment

Equipment	Minimum Specifications	Recommended Model
AC Calibrator	DC Voltage: 0 to ± 1020 V AC Voltage: 1 mV to 1020 V, 10 Hz to 500 kHz, Sine AC Current: 29 μ A to 20.5 A, 10 Hz to 30 kHz, Sine Ohms: 0 to 1100 M Ω	Fluke 5520A
50-Turn Current Coil	Uncertainty due to Clampmeter/ Coil Interaction: \pm (0.25% of effective output + 0.5A), for toroidal-wound current clamps, such as the Fluke 80I and 80I-1000. \pm (0.50% of effective output + 0.5A), for current clamps like the Fluke 80i-kw, 80i-400, 80i-410, 80i-500, 80i-1010, Fluke 31, Fluke 33, or equivalent.	Fluke 5500A/Coil
Mirror		

Testing the Display

Test the display by turning the Meter on while holding down the HOLD button. Check all segments for clarity and contrast. Refer to Figure 2.

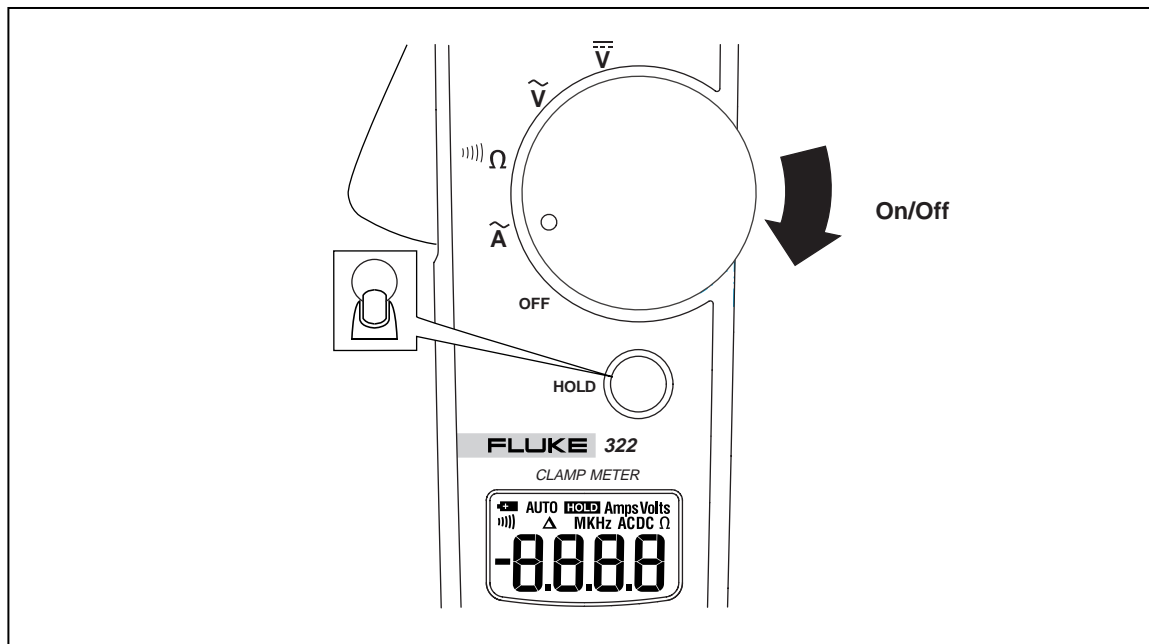

Figure 2. Testing the Display

ade01f.eps

Hold Button Test

To test the HOLD button, turn the Meter on and push the hold button. Each button push will cause the Meter to beep.

Preparing for the Performance Test**⚠ Warning**

To avoid possible electric shock or personal injury:

- Do not perform the following procedures unless qualified to do so. Some procedures involve the use of high voltages.
- Before handling the test connections and in between tests, make sure the calibrator is in standby mode (STBY).

To prepare for the performance test:

1. Make sure that you have the required equipment, see Table 1.
2. Warm up the calibrator as required by its specifications.
3. Allow the temperature of the UUT to stabilize at room temperature ($23\text{ }^{\circ}\text{C} \pm 5\text{ }^{\circ}\text{C}$ [$73\text{ }^{\circ}\text{F} \pm 9\text{ }^{\circ}\text{F}$]).

Performance Test Procedure

To test each of the Meter's functions and operating ranges, do the following:

1. Connect the source to the Meter's V Ω and COM input jacks.
2. Referring to Table 2 for the 321 and Table 3 for the 322, put the Meter in the desired function and range for each test.
3. Apply the indicated output from the 5520A Calibrator.
4. When using the amp function on the 5520A, make sure LCOMP on the 5520A is ON.
5. The reading on the Meter display should be within the low and high limits shown in the table.
6. Repeat steps 1-4 for each function and range in Table 2 or Table 3.

If the Meter fails to perform within the low-high range indicated for each test in Table 2 or Table 3, the Meter needs to be calibrated and adjusted, or requires some repair.

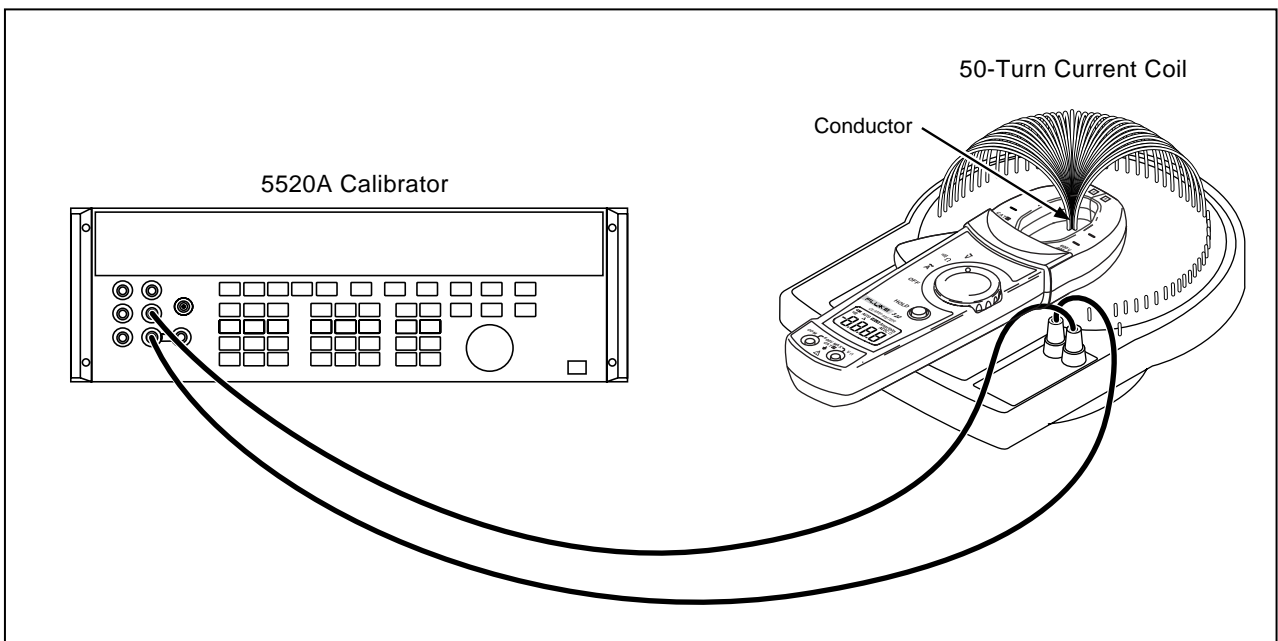

Figure 3. 32x Amps/Hz Verification Setup

ade071.eps

Table 2. Performance Tests 321

Functional Test	5520 output	Nominal	Low Limit	High Limit
AC Amps	0.7 A @ 50 Hz	35 A @ 50 Hz	33.8	36.2
	0.7 A @ 400 Hz	35 A @ 400 Hz	33.4	36.6
	6 A @ 60 Hz	300 A @ 60 Hz	294.1	305.9
	7 A @ 50 Hz	350 A @ 50 Hz	343.2	356.8
	7 A @ 400 Hz	350 A @ 400 Hz	339.0	361.0
Ohms	30 Ohm	30 Ohms	29.2	30.8
			Beeper must be on	
	50 Ohm	50 Ohms	49.0	51.0
			Beeper must be off	
	350 Ohm	350 Ohms	346.0	354.0
AC Volts	35 V @ 50 Hz	35 V @ 50 Hz	34.0	36.0
	350 V @ 60 Hz	350 V @ 60 Hz	345.3	354.7
	600 V @ 60 Hz	600 V @ 60 Hz	592.3	607.7
	35 V @ 400 Hz	35 V @ 400 Hz	34.0	36.0
	350 V @ 400 Hz	350 V @ 400 Hz	345.3	354.7
	600 V @ 400 Hz	600 V @ 400 Hz	592.3	607.7

Table 3. Performance Tests 322

Functional Test	5520A Output	Nominal	Low Limit	High Limit
AC Amps	0.6 A @ 60 Hz	30 A @ 60 Hz	28.9	31.1
	0.07 A @ 50 Hz	3.5 A @ 50 Hz	2.9	4.1
	0.7 A @ 50 Hz	35 A @ 50 Hz	33.4	36.6
	0.07 A @ 400 Hz	3.5 A @ 400 Hz	2.9	4.1
	0.7 A @ 400 Hz	35 A @ 400 Hz	33.4	36.6
	1 A @ 50 Hz	50 A @ 50 Hz	48.6	51.4
	7 A @ 50 Hz	350 A @ 50 Hz	343.2	356.8
	7 A @ 400 Hz	350 A @ 400 Hz	339.0	361.0
	1 A @ 400 Hz	50 A @ 400 Hz	48.0	52.0
Ohms	30 Ohm	30 Ohms	29.2	30.8
			Beeper must be on	
	50 Ohm	50 Ohms	49.0	51.0
			Beeper must be off	
	350 Ohm	350 Ohms	346.0	354.0
AC Volts	35 V @ 50 Hz	35 V @ 50 Hz	34.0	36.0
	350 V @ 60 Hz	350 V @ 60 Hz	345.3	354.7
	600 V @ 60 Hz	600 V @ 60 Hz	592.3	607.7
	35 V @ 400 Hz	35 V @ 400 Hz	34.0	36.0
	350 V @ 400 Hz	350 V @ 400 Hz	345.3	354.7
	600 V @ 400 Hz	600 V @ 400 Hz	592.3	607.7
DC Volts	-350 V	-350V	-355.8	-344.2
	35 V	35V	33.9	36.1
	350 V	350V	344.2	355.8
	600 V	600V	590.5	609.5

321 Calibration Adjustment

Use the following steps to adjust the calibration of the 321 (refer to Figure 4):

1. Remove the screws on the bottom of the Meter.
2. Lift off the top case.
3. Apply 600.0 V 50 Hz from the 5520A.
4. Adjust VR1 until display reads within 1.0 V.
5. Apply 4 A 50 Hz from the 5520A to the 50-turn coil. The 50-turn coil will make the meter read 200.0 A 50 Hz .
6. Adjust VR2 until the display reads within 0.5 A. A mirror will need to be used because the calibration point cannot be seen from the top side of the meter.
7. Replace the top case.
8. Replace the case screws.
9. Verify the calibration by going through the performance test procedures.

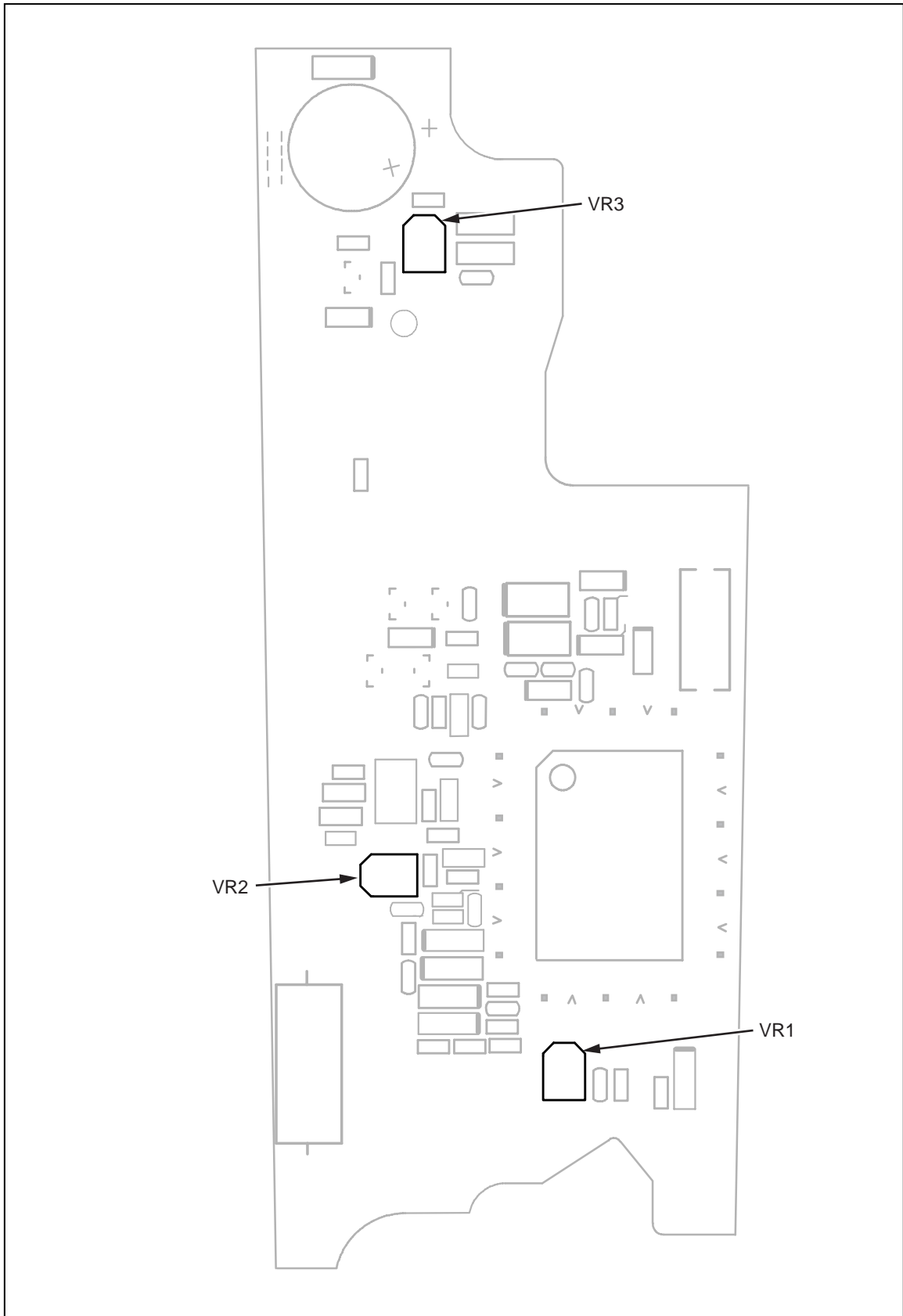

Figure 4. Calibration Adjustment Points (321)

ade05f.eps

322 Calibration Adjustment

Use the following steps to adjust the calibration of the meter (refer to Figure 5):

1. Turn the meter to DC V.
2. Remove the screws on the bottom of the Meter.
3. Lift off the top case.
4. Apply 300.0 V DC from the 5520A to the Meter..
5. Adjust VR1 until the UUT (Unit Under Test) display reads within 0.1 V.
6. Change the meter to the V AC function.
7. Apply 300 V @ 60 Hz.
8. Adjust VR2 until the UUT display reads within 0.1. V.
9. Change to the A AC function.
10. Apply 6 A 60 Hz to the 50-turn coil. The 50-turn coil will cause the Meter read this as 300.0 A 60Hz.
11. Adjust VR3 until this difference between steps 8 and 11 is within 0.1 A. A mirror will need to be used because the calibration point cannot be seen from the top side of the meter.
12. Replace top case.
13. Verify the calibration by going through the Performance Test procedures.

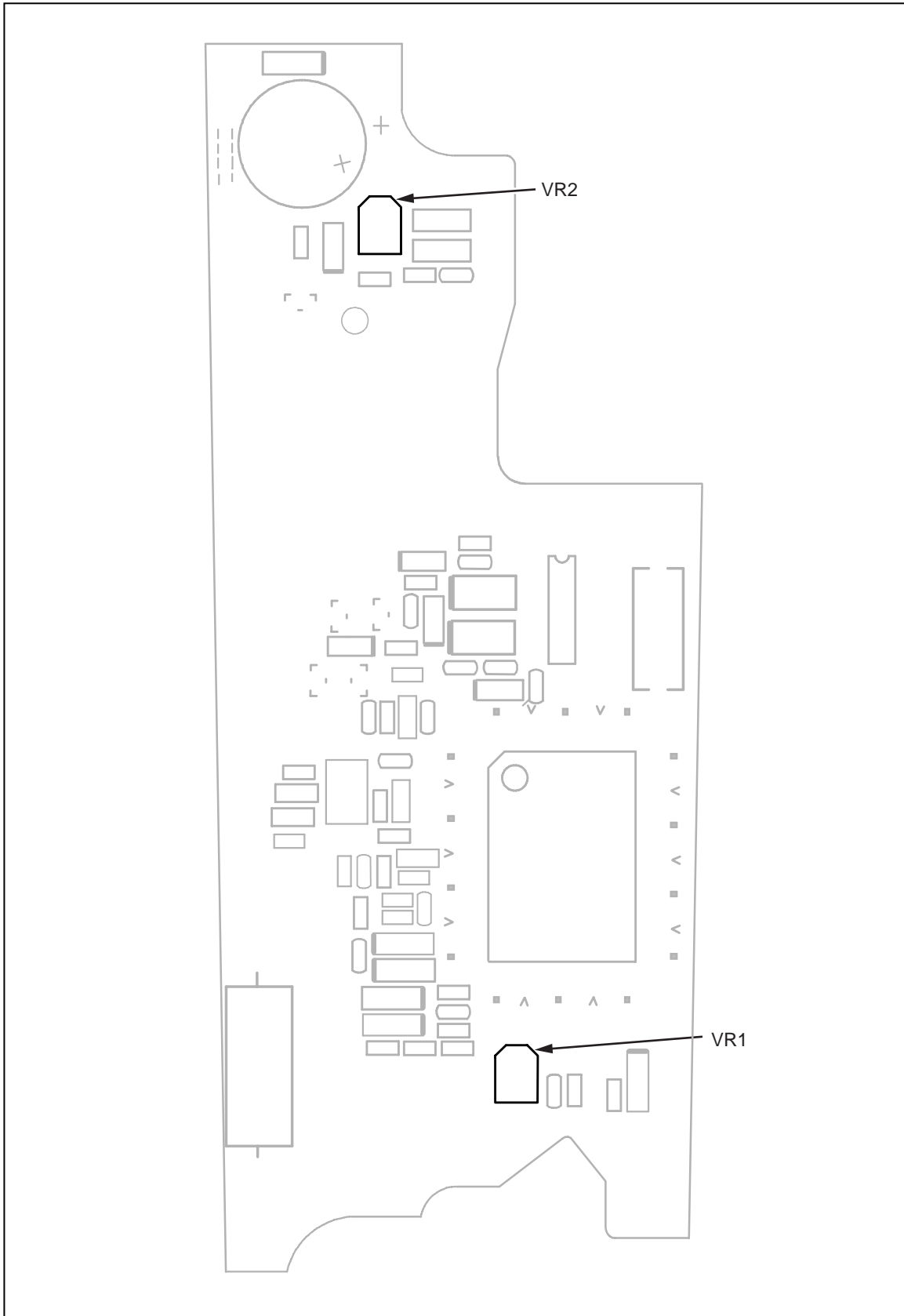
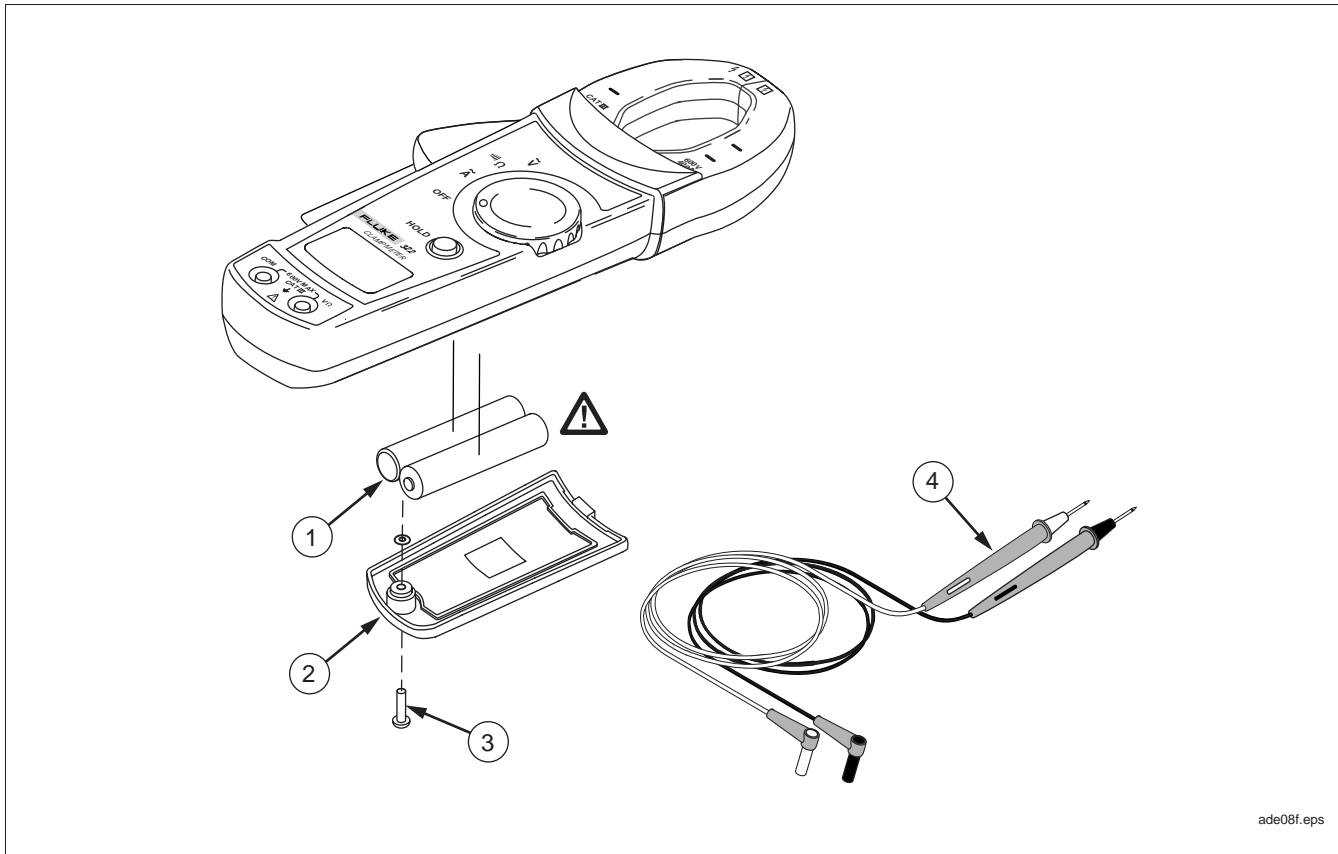

Figure 5. Calibration Adjustment Points 322

ade06f.eps

User-Replaceable Parts and Accessories



ade08f.eps

Item #	Description	Part No	Qty
①	Battery, 1.5V, 0-150mA, AA Alkaline	376756	2
②	Battery Door	1630734	1
③	Battery Door Screw	1611694	1
④	TL75 Test Lead Set**	855705	1
Not Shown	321, 322 Safety Sheet	1615215	1
Not Shown	321, 322 Instruction Card	1615194	1
Not Shown	Calibration Information (this document)	1631636	1

** Fluke accessories are available from your authorized Fluke distributor.

Figure 6. User-Replaceable Parts and Accessories

LIMITED WARRANTY AND LIMITATION OF LIABILITY

This Fluke product is warranted to be free from defects in material and workmanship under normal use and service. The warranty period is 2 years and begins on the date of shipment. Parts, product repairs, and services are warranted for 90 days. This warranty extends only to the original buyer or end-user customer of a Fluke authorized reseller, and does not apply to fuses, disposable batteries, or to any product which, in Fluke's opinion, has been misused, altered, neglected, contaminated, or damaged by accident or abnormal conditions of operation or handling. Fluke warrants that software will operate substantially in accordance with its functional specifications for 90 days and that it has been properly recorded on non-defective media. Fluke does not warrant that software will be error free or operate without interruption.

Fluke authorized resellers shall extend this warranty on new and unused products to end-user customers only but have no authority to extend a greater or different warranty on behalf of Fluke. Warranty support is available only if product is purchased through a Fluke authorized sales outlet or Buyer has paid the applicable international price. Fluke reserves the right to invoice Buyer for importation costs of repair/replacement parts when product purchased in one country is submitted for repair in another country.

Fluke's warranty obligation is limited, at Fluke's option, to refund of the purchase price, free of charge repair, or replacement of a defective product which is returned to a Fluke authorized service center within the warranty period.

To obtain warranty service, contact your nearest Fluke authorized service center to obtain return authorization information, then send the product to that service center, with a description of the difficulty, postage and insurance prepaid (FOB Destination). Fluke assumes no risk for damage in transit. Following warranty repair, the product will be returned to Buyer, transportation prepaid (FOB Destination). If Fluke determines that failure was caused by neglect, misuse, contamination, alteration, accident, or abnormal condition of operation or handling, including overvoltage failures caused by use outside the product's specified rating, or normal wear and tear of mechanical components, Fluke will provide an estimate of repair costs and obtain authorization before commencing the work. Following repair, the product will be returned to the Buyer transportation prepaid and the Buyer will be billed for the repair and return transportation charges (FOB Shipping Point).

THIS WARRANTY IS BUYER'S SOLE AND EXCLUSIVE REMEDY AND IS IN LIEU OF ALL OTHER WARRANTIES, EXPRESS OR IMPLIED, INCLUDING BUT NOT LIMITED TO ANY IMPLIED WARRANTY OF MERCHANTABILITY OR FITNESS FOR A PARTICULAR PURPOSE. FLUKE SHALL NOT BE LIABLE FOR ANY SPECIAL, INDIRECT, INCIDENTAL OR CONSEQUENTIAL DAMAGES OR LOSSES, INCLUDING LOSS OF DATA, ARISING FROM ANY CAUSE OR THEORY.

Since some countries or states do not allow limitation of the term of an implied warranty, or exclusion or limitation of incidental or consequential damages, the limitations and exclusions of this warranty may not apply to every buyer. If any provision of this Warranty is held invalid or unenforceable by a court or other decision-maker of competent jurisdiction, such holding will not affect the validity or enforceability of any other provision.

Fluke Corporation
P.O. Box 9090
Everett, WA 98206-9090
U.S.A.

Fluke Europe B.V.
P.O. Box 1186
5602 BD Eindhoven
The Netherlands

11/99

To register this product, go to www.register.fluke.com

